

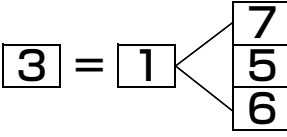

<b>1R</b>	車番	印	3単 $3 = 7$  $3 = 1$  $7 = 1$ 
	1	X	
	2		
	3	◎	
	4		
	5	△	
	6		
	7	○	
		並び：提供 赤競新聞	164・2・735

<b>2R</b>	車番	印	3単 $1 = 3$  $1 = 4$  $3 = 4$ 
	1	◎	
	2		
	3	○	
	4	X	
	5		
	6	△	
	7		
		並び：提供 赤競新聞	16・34・7・52

<b>3R</b>	車番	印	3単 $1 = 3$  $1 = 5$  $5 - 2$ 
	1	◎	
	2	△	
	3	○	
	4		
	5	X	
	6		
	7		
		並び：提供 赤競新聞	13・257・46

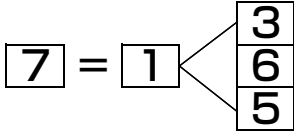

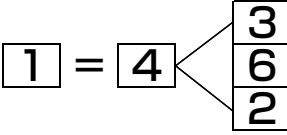
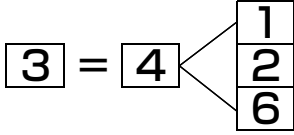
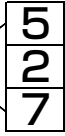
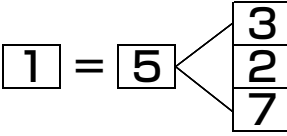
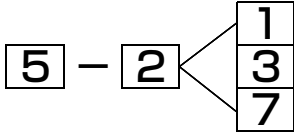
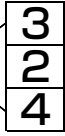
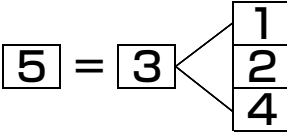
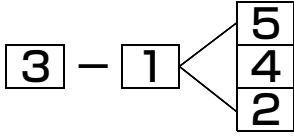
<b>4R</b>	車番	印	3単 $5 = 1$  $5 = 3$  $3 - 1$ 
	1	○	
	2	△	
	3	X	
	4		
	5	◎	
	6		
	7		
		並び：提供 赤競新聞	51・26・347



5R	車番	印	3単 $2 = 5$ $\begin{cases} 3 \\ 7 \\ 1 \end{cases}$ $2 = 3$ $\begin{cases} 5 \\ 7 \\ 1 \end{cases}$ $3 - 7$ $\begin{cases} 2 \\ 4 \\ 5 \end{cases}$
	1		
	2	◎	
	3	X	
	4		
	5	○	
	6		
	7	△	
		並び：提供 赤競新聞	16・25・374

6R	車番	印	3単 $1 = 2$ $\begin{cases} 7 \\ 3 \\ 4 \end{cases}$ $1 = 7$ $\begin{cases} 2 \\ 3 \\ 4 \end{cases}$ $1 - 3$ $\begin{cases} 2 \\ 7 \\ 4 \end{cases}$
	1	◎	
	2	○	
	3	△	
	4		
	5		
	6		
	7	X	
		並び：提供 赤競新聞	1・2・4・5・6・3・7

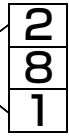
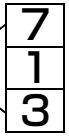

7R	車番	印	3単 $4 = 6$ $\begin{cases} 2 \\ 7 \\ 3 \end{cases}$ $4 = 2$ $\begin{cases} 6 \\ 7 \\ 3 \end{cases}$ $4 - 7$ $\begin{cases} 6 \\ 2 \\ 3 \end{cases}$
	1		
	2	X	
	3		
	4	◎	
	5		
	6	○	
	7	△	
		並び：提供 赤競新聞	2・1・4・3・7・6・5

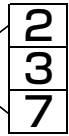
8R	車番	印	3単 $2 = 8$ $\begin{cases} 7 \\ 9 \\ 3 \end{cases}$ $2 = 7$ $\begin{cases} 8 \\ 9 \\ 3 \end{cases}$ $7 = 9$ $\begin{cases} 1 \\ 2 \\ 8 \end{cases}$
	1		
	2	◎	
	3		
	4		
	5		
	6		
	7	X	
	8	○	
9	△		
		並び：提供 赤競新聞	35・791・82・64

<b>9R</b>	車番	印	3単 $9 = 7$  $9 = 8$  $7 = 2$ 
	1		
	2		
	3	△	
	4		
	5		
	6		
	7	○	
	8	×	
	9	◎	
	並び：提供 赤競新聞	816・35・9724	

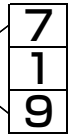
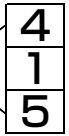
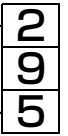
<b>10R</b>	車番	印	3単 $1 = 9$  $1 = 2$  $2 = 7$ 
	1	◎	
	2	×	
	3	△	
	4		
	5		
	6		
	7		
	8		
	9	○	
	並び：提供 赤競新聞	194・872・536	

<b>11R</b>	車番	印	3単 $2 = 4$  $2 = 7$  $7 = 1$ 
	1		
	2	◎	
	3		
	4	○	
	5		
	6		
	7	×	
	8		
	9	△	
	並び：提供 赤競新聞	175・6・428・39	

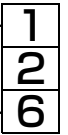
<b>12R</b>	車番	印	3単 $1 = 7$  $1 = 3$  $7 = 3$ 
	1	◎	
	2	△	
	3	×	
	4		
	5		
	6		
	7	○	
	8		
	9		
	並び：提供 赤競新聞	719・825・436	