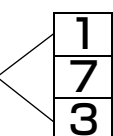
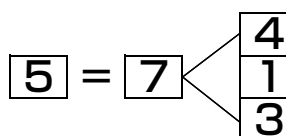
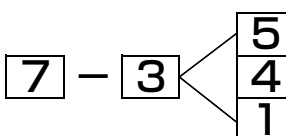
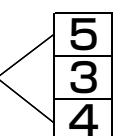
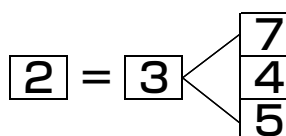
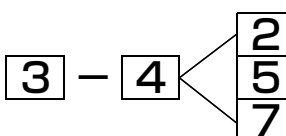
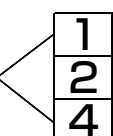
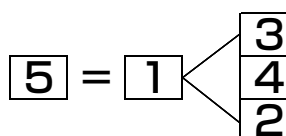
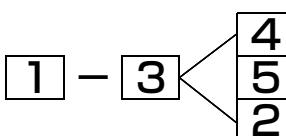
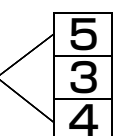
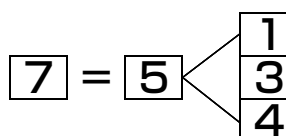
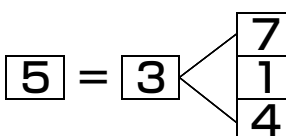
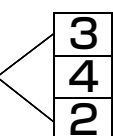
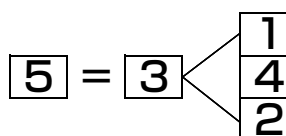
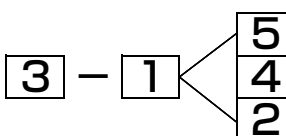

1R	車番	印	3単 $5 = 4$  $5 = 7$  $7 - 3$ 
	1	△	
	2		
	3		
	4	○	
	5	◎	
	6		
	7	X	
		並び：提供 赤競新聞	541・2・6・73

2R	車番	印	3単 $2 = 7$  $2 = 3$  $3 - 4$ 
	1		
	2	◎	
	3	X	
	4	△	
	5		
	6		
	7	○	
		並び：提供 赤競新聞	2756・341

3R	車番	印	3単 $5 = 3$  $5 = 1$  $1 - 3$ 
	1	X	
	2	△	
	3	○	
	4		
	5	◎	
	6		
	7		
		並び：提供 赤競新聞	267・14・35

4R	車番	印	3単 $7 = 1$  $7 = 5$  $5 = 3$ 
	1	○	
	2		
	3	△	
	4		
	5	X	
	6		
	7	◎	
		並び：提供 赤競新聞	71・42・6・53

5R	車番	印	3単 $5 = 1$  $5 = 3$  $3 - 1$ 
	1	○	
	2		
	3	X	
	4	△	
	5	◎	
	6		
	7		
		並び：提供 赤競新聞	2・1・4・5・3・7・6

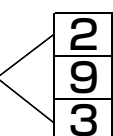
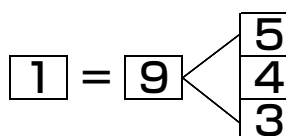
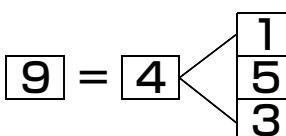
6R	車番	印	3単 $1 = 5$  $1 = 9$  $9 = 4$ 
	1	◎	
	2		
	3		
	4		
	5	○	
	6	△	
	7		
	8		
9	X		
		並び：提供 赤競新聞	152・4937・86

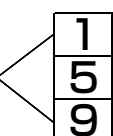
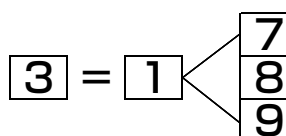
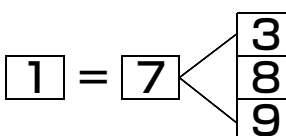
7R	車番	印	3単 $3 = 8$  $3 = 1$  $1 = 7$ 
	1	X	
	2		
	3	◎	
	4		
	5		
	6		
	7		
	8	○	
9	△		
		並び：提供 赤競新聞	92・17・4・3856

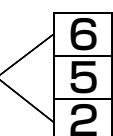
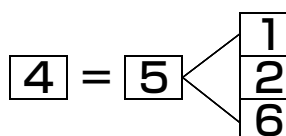
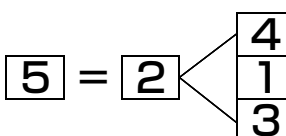
8R	車番	印	3単 $4 = 1$  $4 = 5$  $5 = 2$ 
	1	○	
	2		
	3		
	4	◎	
	5	X	
	6	△	
	7		
		並び：提供 赤競新聞	52・146・37

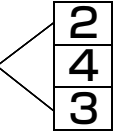
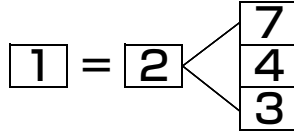
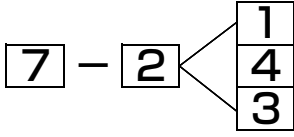
9R	車番	印	3単 $1 = 7$  $1 = 2$  $7 - 2$ 
	1	◎	
	2	X	
	3		
	4	△	
	5		
	6		
	7	○	
		並び：提供 赤競新聞	3・1・4・2・6・7・5

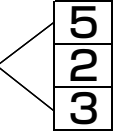
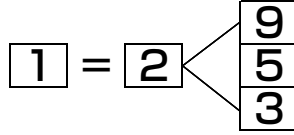
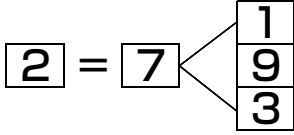
10R	車番	印	3単 $1 = 9$  $1 = 2$  $2 = 7$ 
	1	◎	
	2	X	
	3		
	4		
	5	△	
	6		
	7		
	8		
9	○		
		並び：提供 赤競新聞	27・915・38・64

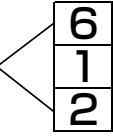
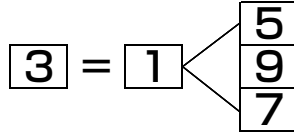
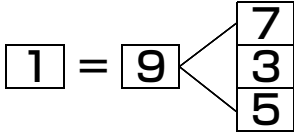
11R	車番	印	3単 $3 = 5$  $3 = 1$  $1 = 9$ 
	1	X	
	2		
	3	◎	
	4		
	5	○	
	6		
	7		
	8		
9	△		
		並び：提供 赤競新聞	197・28・4・356

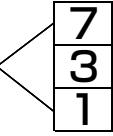
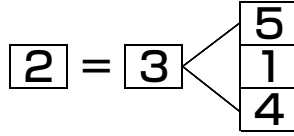
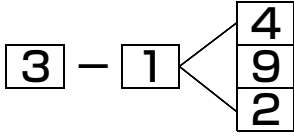
12R	車番	印	3単 $2 = 5$  $2 = 3$  $3 - 1$ 
	1	△	
	2	◎	
	3	X	
	4		
	5	○	
	6		
	7		
	8		
9			
		並び：提供 赤競新聞	527・619・834